



TruPunch:

A new standard  
in punching  
efficiency.

# Uniquely efficient.

## Contents

Uniquely efficient. _____	2
Why TruPunch is impressive. _____	4
Punching tools and accessories. _____	5
Intelligent punching. _____	6
Totally flexible. _____	7
<b>TruPunch 1000</b> _____	8
<b>TruPunch 2000</b> _____	12
<b>TruPunch 3000</b> _____	16
<b>TruPunch 5000</b> _____	20
Components that pay off. _____	24
Software: Programmed for success. _____	26
TruServices: Service like no other. _____	27

TruPunch machines from TRUMPF offer you the flexibility to process a diverse range of parts. The many and varied applications stretch from simple to complex sheet metal parts with serial forming and excellent surface and edge quality. This means you can process a multitude of different parts entirely on one machine – and that fully automated if desired.

TruPunch machines are extremely economical and efficient. They provide particular savings in their use of energy and material resources. The broad choice of high-quality punching tools made by TRUMPF enable flexibility when processing to the highest standards

## TruPunch: Benefits at a glance.

- 1 Resource-efficient processing.
- 2 Punching, forming and deburring (on one machine).
- 3 Full tool flexibility.
- 4 Quality to suit every requirement.
- 5 Custom automation.





### TruPunch 1000

**Economical entry-level machine.** This versatile machine offers an ideal start to punching. It is particularly easy to operate, offers good value for money, and takes up little space.



### TruPunch 2000

**Powerful basic machine.** The compact TruPunch 2000 paves the way for the automated punching world of TRUMPF. Being highly productive and flexible, the machine manufactures a wide range of parts – and that at a very attractive price.



### TruPunch 3000

**Resource-efficient universal machine.** Thanks to skeleton-free processing, the TruPunch 3000 has material savings of 10% on average. Its clever automation makes it extremely user-friendly.



### TruPunch 5000

**Productive high-end machine.** The TruPunch 5000 is the market leader in productivity, process reliability and flexibility. Individual automation solutions guarantee diverse applications and enable optimal throughput, especially in multishift operation.

## Why TruPunch is impressive.

Profitably machining standard contours and formed sections.



Punch in three dimensions. The punching head is suitable for holes as well as for three-dimensional contours such as fishplates or threads. You can process your parts entirely on one machine, with no need for downstream work steps.

- Flexible and cost-efficient thanks to 360° tool rotation.
- Versatile forming.
- High-speed processing.
- First-class punch contours.
- Fast changeover times.

Both stable and accessible.

The design principle of all TruPunch machines is an open C frame. This means the machines and workpieces are accessible from three sides. There is plenty of room for loading and unloading – whether by hand or automatically. The machine's high level of stability also ensures accuracy.



- Good access to the machine from three sides.
- High accuracy.
- Fast unloading of parts.
- Modular automation.

# Punching tools and accessories.

## Wide selection of high-quality punching tools.

For over 40 years, TRUMPF has been providing its customers with top-quality punching tools and much more besides. No matter what challenges you face, we can offer you a range of support – from technical consulting to design assistance, right on to the prompt delivery of your tools.

- **Punching tools:** Within our leading tool system, Classic, we offer a wide range of shapes and coatings as well as free punch shears. With EasyUse in the standard equipment offer, easy setup is guaranteed.
- **Slitting tools:** Simple separation contours, the cutting of formed areas or visible edges without nibbling marks can all be performed flexibly and inexpensively.
- **Forming tools:** By forming the sheet plastically you can do a variety of forming operations. TRUMPF tools enable you to perform the complete processing spectrum reliably on one machine. A very high processing speed and part quality without any visible forming marks can be achieved by using roller technology. Furthermore, we also offer you the appropriate solution for specialized applications such as deburring.
- **Embossing and marking tools:** Whether you are looking to inscribe serial numbers, the year of manufacture or your corporate logo, we can provide the tools you need for fast and efficient marking.
- **Tooling accessories:** Make set-up and maintenance easier and increase the service life of your tools. Achieve optimal results with precisely calibrated and perfectly sharpened tools.



Slitting tool MultiShear.



Roller deburring tool.

## Intelligent punching.

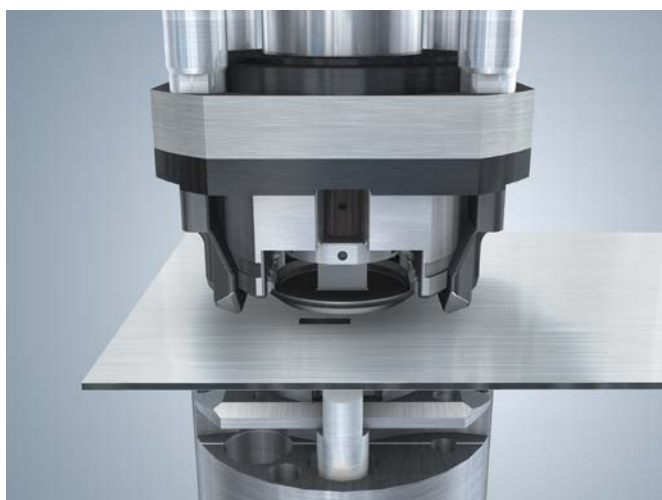

The wear-free ram guidance system combined with the mechanism that actively retracts the punch ensures accurate results and maximum process reliability.



Thanks to 360° rotation, you can punch at whatever angle you like.

### Versatile and cost-efficient thanks to 360° tool rotation.

Tools fit snugly into the punching head. One of the biggest advantages of the head design is that it can rotate any tool to the angle that is required, regardless of the tool's shape, size or position in the magazine.

#### Benefits of 360° rotation at a glance:

- Ability to position tools at any angle.
- Easily programmed.
- More efficient use of materials thanks to versatile sheet layout.
- Fast changeover times.
- Low tool costs.

# Totally flexible.

## ► Skeleton-free processing

The scrap skeleton that remains on the machine in a conventional production strategy is time-consuming to remove. In skeleton-free processing, by contrast, the sheet is totally pierced, leaving not even an edge strip behind. This offers multiple advantages.

### Process-reliable

- Finished parts can be unloaded with higher process reliability.
- Small parts are unloaded reliably even when the part chute is open.
- Residual pieces of sheet metal are automatically cut up and removed.

### Material-efficient

- Common cuts ensure optimal material usage.
- An average of 10% higher sheet utilization reduces material costs.
- Smaller bits of residual material simplify logistics and yield higher scrap prices.

### Operator-friendly

- Working without a scrap skeleton increases safety.
- Residual pieces of sheet metal can be sorted by material fully automatically.
- The sorting flap routes good parts and scrap to specific containers.



If necessary, the machine can turn your parts before unloading.

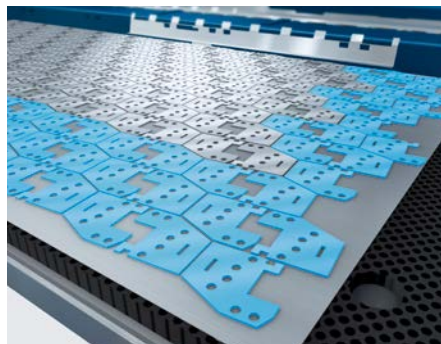

Material-efficient thanks to skeleton-free processing.

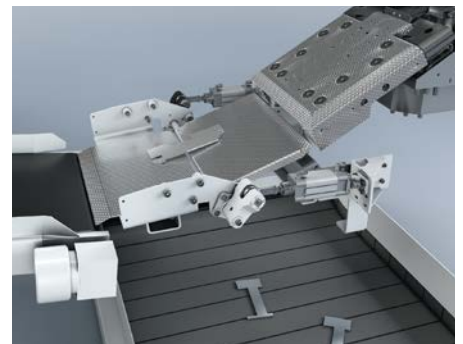

The sorting flap separates scrap from good parts.

# TruPunch 3000

## Resource-efficient universal machine.

TRUMPF is the first manufacturer in the world to offer punching machines designed for skeleton-free processing. This innovation reduces material requirements by an average of 10%, increases process reliability and is extremely user-friendly. With its electric punching head and an average power consumption of 5.6 kW, the TruPunch 3000 is a very energy-efficient machine.

## Careful material handling.

The adjustable die height enables you to process sheet thicknesses of up to 6.4 mm and obtain top-quality and scratch-free results. For even more convenience, this compact machine can be equipped with an extensive range of automation options designed to make ideal use of the space available.

## TruPunch 3000: Benefits at a glance.

- 1 High resource efficiency.
- 2 Skeleton-free processing.
- 3 Scratch-free material handling.
- 4 Various automation solutions.
- 5 Flexible part removal.



Energy-efficient electric punching head.



Extensive automation.

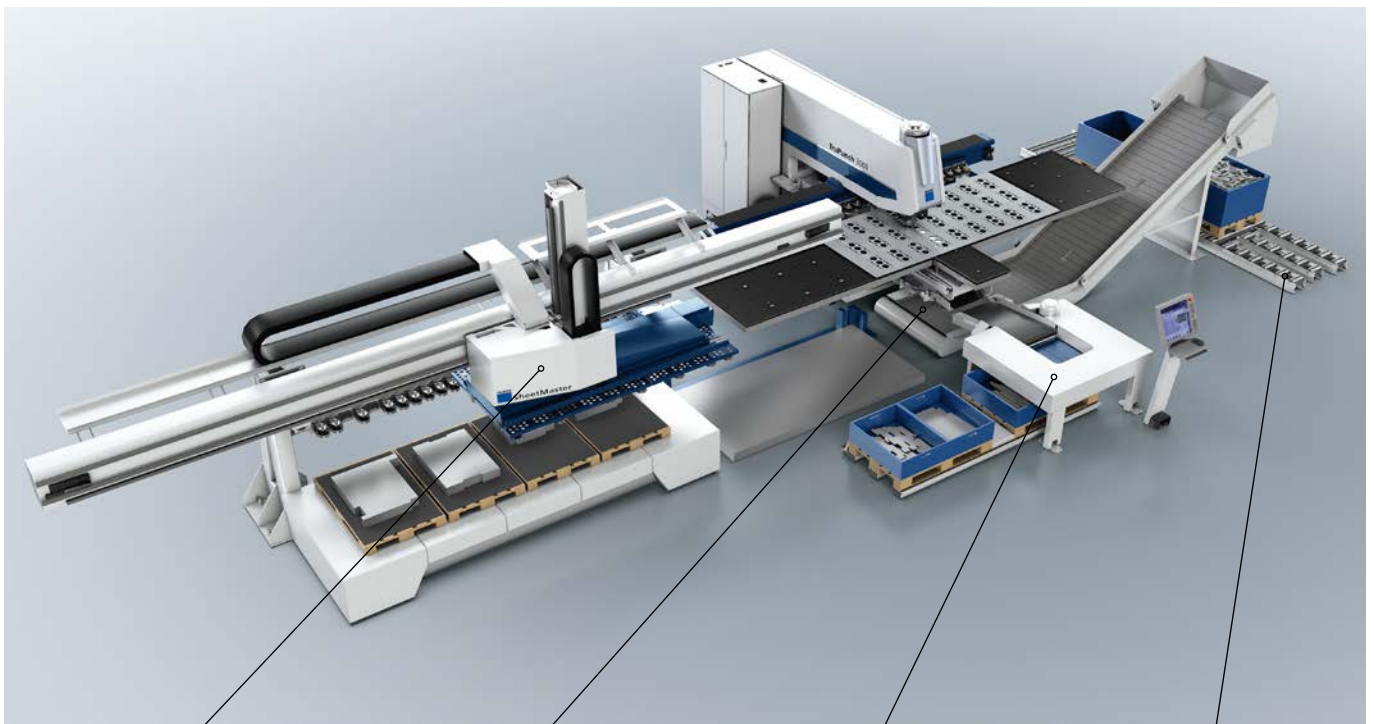

**SheetMaster:**

Performs speedy and process-reliable loading and unloading, stacking and sorting. Optional tool changer with space for additional tools.



**Sorter:**

Separates good parts from scrap.

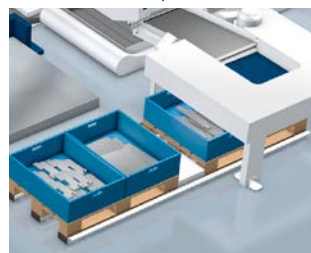

**SortMaster Box Linear with part slider:**

Ensures virtually scratch-free sorting of good parts into containers, moving in a linear direction.



**DisposeMaster:**

Sorts sheet metal scrap, including slugs, according to material type.



<b>Technical data:</b>		
	<b>TruPunch 3000 medium format</b>	<b>TruPunch 3000 large format</b>
Work area (X x Y)	2500 x 1250 mm	3000 x 1500 mm
<b>Capacity</b>		
Max. sheet thickness	6.4 mm	6.4 mm
Max. punching force	180 kN	180 kN
Max. presser foot force	20 kN	20 kN
Max. workpiece weight	160 kg	230 kg
<b>Speeds</b>		
X axis	90 m/min	90 m/min
Y axis	60 m/min	60 m/min
Simultaneous (X and Y)	108 m/min	108 m/min
C axis	330 rpm	330 rpm
Max. stroke rate when punching (E = 1 mm)	1000 1/min	800 1/min
Max. stroke rate when marking	2500 1/min	2500 1/min
<b>Max. acceleration<sup>[1]</sup></b>		
X axis	12 m/s <sup>2</sup>	12 m/s <sup>2</sup>
Y axis	6 m/s <sup>2</sup>	5 m/s <sup>2</sup>
C axis	350 1/s <sup>2</sup>	350 1/s <sup>2</sup>
<b>Tools</b>		
Linear magazine	18 tools with 2 clamps	21 tools with 3 clamps
No. when using MultiTool	18 – 180	21 – 210
MultiTool	5/10 stations	5/10 stations
<b>Tool change time</b>		
Single tool	3.0 s	3.0 s
MultiTool	0.3 s	0.3 s
<b>Accuracy<sup>[2]</sup></b>		
Positioning accuracy Pa	± 0.1 mm	± 0.1 mm
Repeatability Ps	± 0.03 mm	± 0.03 mm
<b>TRUMPF CNC control</b>	Bosch Rexroth MTX CMP70	Bosch Rexroth MTX CMP70
<b>Programmable unloading of parts</b>		
Max. part size with part removal flap	500 x 500 mm	500 x 500 mm
<b>Space requirements<sup>[3]</sup></b>		
Including safety barriers	5000 x 6500 mm	5800 x 7650 mm
<b>Power consumption</b>		
Average power consumption during production	5.6 kW	5.6 kW
Active auto-shutdown	0.3 kW	0.3 kW

<sup>[1]</sup> Up to 100 kg sheet weight.



<sup>[2]</sup> Achievable workpiece accuracy depends on various factors, including workpiece type, its pretreatment, sheet size and position in the work area. In accordance with VDI/DGQ 3441. Measuring length 1 m.

<sup>[3]</sup> Approximate values. Exact specifications can be found in the most recent installation plan. Subject to alteration. Only specifications in our offer and order confirmation are binding.

# Components that pay off.

Efficient, economical production through automation.

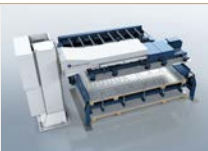
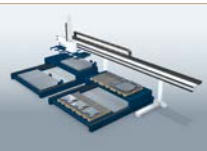
- Everything from a single source: there are no interface problems.
- Optimized material flow and enhanced process reliability boost productivity.
- Increase capacity by running highly automated multishift operations up to 24 hours a day.
- Careful material handling ensures more efficient material usage.
- Clearly organized storage gives you fast access to materials and saves space.

	SheetMaster	SheetMaster Compact	Cart systems	SortMaster Pallet	SortMaster Box
					
<b>Compatible machines:</b>					
TruPunch 2000		■			
TruPunch 3000	■	■	■		
TruPunch 5000	■		■	■	■

<sup>[1]</sup> With integrated tool changer (optional with SheetMaster).

<sup>[2]</sup> With option "skeleton-free processing".

**SheetMaster:** Fast and reliable loading and unloading, stacking and sorting.

**SheetMaster Compact:** Space-saving and inexpensive entry-level automation solution for loading sheets and unloading microjoint sheets and scrap skeletons.

**Cart systems:** Double your loading and unloading capacity by deploying versatile storage and sorting solutions for raw materials and finished parts.

**SortMaster Pallet:** Sort and stack finished parts on up to 6 europallets.

**SortMaster Box:** Sort finished parts into 4 standardized, stackable containers.

**SortMaster Box Linear:** Virtually scratch-free sorting of finished parts into containers traveling on horizontal rails.





**GripMaster:** Fast and reliable removal and stacking of sheet skeletons parallel to the loading process.

**ToolMaster Linear:** Modular tool storage system for 18, 54 or 90 tool stations.

**DisposeMaster:** Conveniently sorts shredded sheet skeletons and stubs according to material type.

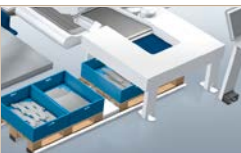
**TruStore:** Modular and upgradable storage and shelving system provides a well-organized, space-saving storage solution.

**Stopa storage solutions:** For special requirements we also offer highly customizable storage solutions in cooperation with our partner, Stopa.

SortMaster Box Linear	GripMaster	ToolMaster Linear	DisposeMaster	TruStore	Stopa storage solutions
					
■		[1]	■ [2]	■	■
■	■	■		■	■

Software:

Programmed  
for success.



TruTops Boost takes you faster than ever from the geometry to the NC program.

TRUMPF's TruTops Boost is the software solution for designing and programming laser, punching and bending machines that lets you increase your performance at the touch of a button. The software combines all order processing steps, from the geometry through to the completed NC program, in a single all-in-one solution. Its intuitive operating philosophy guides you through the software in a simple, process-oriented manner while allowing you to keep an overview of your orders. Thanks to its numerous automated functions, the innovative Boost technology also makes you unbeatably fast. With it, you become more profitable and boost your business!

Talk to your TRUMPF contact to find out when TruTops Boost will be available to you. Until then, our TruTops Punch software can offer you optimum support. We recommend our TruTops Fab software as the ideal production control system for your requirements.

TruTops Boost: Your benefits at a glance.

- From geometry to NC program faster than ever before.
- Everything monitored: Single software solution for all order processes.
- Everything under control: Intuitive user interface supports flexible working.
- Everything faster: Boost technology with productive automated functions.
- Innovative Boost technology + new operating philosophy = TruTops Boost

TruServices:

Service like  
no other.

Throughout the lifecycle of your machine.

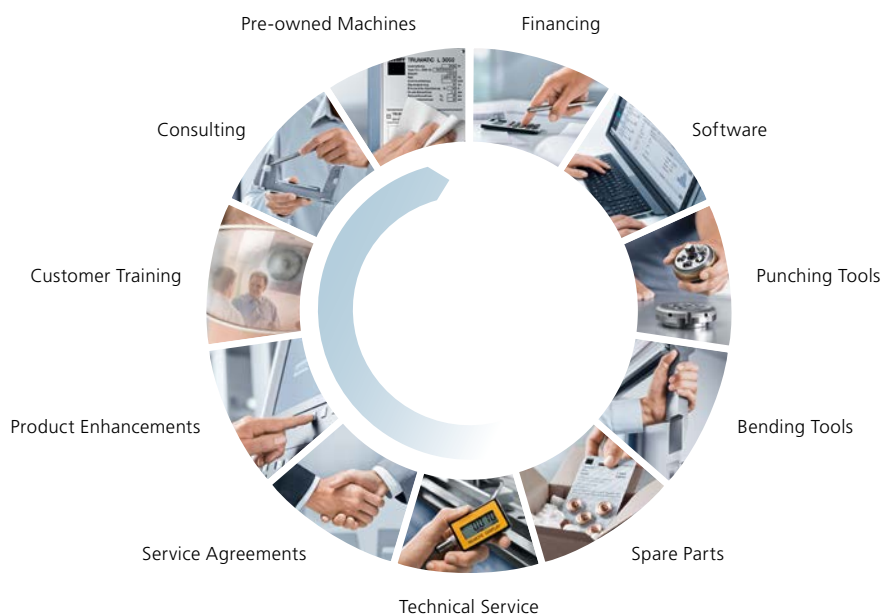

Regardless of the TRUMPF technology you use, you will always get the best service. Thanks to the award-winning spare parts logistics at TRUMPF, we guarantee the highest availability of spare parts and provide you with all the products in the shortest time. TRUMPF offers you individual financing solutions quickly and without a lot of paperwork. Our service technicians are highly trained and always available when you need them. A Service Agreement is the ideal way of ensuring the highest availability of your machine. Should your requirements change,

we have flexible upgrading options and technical innovations that will make your machine even better. Our broad range of training courses with experienced trainers and hands-on practice will also give you a head start in understanding and operating your machine.

The TRUMPF Group ranks among the world's leading manufacturers of production technology and industrial lasers. Technical and efficient solutions for our customers have been our focus since 1923. As a leading technology supplier, TRUMPF is a one-stop shop for all of your technology needs: machines, automation, storage technology and services.

TRUMPF is certified according to ISO 9001:2008  
(for additional information see [www.trumpf.com/en/quality](http://www.trumpf.com/en/quality))

Ident. no. 0372702\_201410\_F – Specifications subject to change without notice.